



# AIR TOOLS

**FP-745TCI**  
**Torque Controlled**  
**1/2-in. Impact Wrench**  
**IMPACTS**

## General Safety Information & Replacement Parts



### TABLE OF CONTENTS

General Safety Information .....	2
Air Compressor and Air Tool Safety .....	2-3
Tool Specifications .....	3
Installation .....	4
Maintenance / Lubrication .....	4
Operation .....	5
Troubleshooting .....	6
Warranty .....	6
Service Parts .....	7



**WARNING:** This product contains lead, a chemical known to the State of California to cause cancer and birth defects or other reproductive harm. **Wash hands after handling.**



**WARNING:** This product contains chemicals known to the State of California to cause cancer and birth defects or other reproductive harm. **Wash hands after handling.**



**WARNING:** Risk of injury to persons. Read and understand operation instructions. Always become familiar with all the instructions and warnings before operating any pneumatic tool.

# Safety Information



## 7.2.2.3 GENERAL SAFETY RULES

- Multiple hazards. Read and understand the safety instructions before installing, operating, repairing, maintaining, changing accessories on, or working near the power tool. Failure to do so can result in serious bodily injury.
- Only qualified and trained operators should install, adjust or use the power tool.
- Do not modify this power tool. Modifications may reduce the effectiveness of safety measures and increase the risks to the operator.
- Do not discard the safety instructions – give them to the operator.
- Do not use a tool if the tool has been damaged.
- Warnings shall be given against the risk of explosion or fire due to the material being processed;
- Warnings shall be given against the risk of cutting.



## 7.2.2.4 PROJECTILE HAZARDS

- Failure of the work piece, of accessories, or even of the tool itself may generate high velocity projectiles.
- Always wear impact-resistant eye protection during operation of the tool. The grade of protection required should be assessed for each use.



## 7.2.2.5 ENTANGLEMENT HAZARDS

- Entanglement hazard - choking, scalping and/or lacerations can occur if neck ware, hair or gloves are not kept away from tool and accessories.

## 7.2.2.6 OPERATING HAZARDS

- Use of the tool may expose the operator's hands to hazards including crushing, impacts, cuts and abrasions and heat. Wear suitable gloves to protect hands.
- Operators and maintenance personnel must be physically able to handle the bulk, weight and power of the tool.
- Hold the tool correctly: be ready to counteract normal or sudden movements – have both hands available.
- Maintain a balanced body position and secure footing.
- Keep hands away from rotating or reciprocation accessories, spindles or other moving parts.
- Release the start and stop device in the case of an interruption of the energy supply
- Use only lubricants recommended by the manufacturer.



## 7.2.2.7 REPETITIVE MOTIONS HAZARDS

- When using a power tool, you may experience discomfort in your hands, arms, shoulders, neck, or other parts of your body.
- While using a power tool, position your body in a comfortable posture. Maintain secure footing and avoid awkward or off-balanced postures. Changing your posture during extended tasks may help avoid discomfort and fatigue.
- If you experience symptoms such as persistent or recurring discomfort, pain, throbbing, aching, tingling, numbness, burning sensation, or stiffness, do not ignore these warning signs. Promptly tell your employer and consult a qualified health professional.

## 7.2.2.8 ACCESSORY HAZARDS

- Only use sizes and types of accessories and consumables that are recommended by the power tool manufacturer.



## 7.2.2.9 WORKPLACE HAZARDS

- Slips, trips and falls are major causes of workplace injury. Be aware of slippery surfaces caused by use of the tool and also of trip hazards caused by the air line or hydraulic hose.
- Proceed with care in unfamiliar surroundings. Hidden hazards may exist, such as electricity or other utility lines.
- This power tool is not intended for use in potentially explosive atmospheres and is not insulated from coming into contact with electric power.
- Make sure there are no electrical cables, gas pipes etc. that could cause a hazard if damaged by use of the tool.



## 7.2.2.10 DUST AND FUME HAZARDS

- Dust from some work processes can cause cancer, birth defects or other respiratory diseases. Risk assessment of these hazards and implementation of appropriate controls is essential.

- If the pneumatic tool is used in a dust filled environment exhaust air can cause a dust hazard
- Dusts and fumes generated when using power tools can cause ill health (for example: cancer, birth defects, asthma and/or dermatitis); risk assessment of these hazards and implementation of appropriate controls of is essential.
- Risk assessment should include dust created by the use of the tool and the potential for disturbing existing dust.
- Operate and maintain the power tool as recommended in these instructions, to minimize dust or fume emissions
- Direct the exhaust so as to minimized disturbance of dust in a dust filled environment
- Where dusts or fumes are created, the priority shall be to control them at the point of emission.
- All integral features or accessories for the collection, extraction or suppression of airborne dust or fumes should be correctly used and maintained in accordance with the manufacturer's instructions.
- Select, maintain and replace the consumable/inserted tool as recommended in these instructions, to prevent an unnecessary increase in dust or fumes
- Use respiratory protection as instructed by your employer or as required by occupational health and safety regulations;



## 7.2.2.11 NOISE HAZARDS

- Unprotected exposure to high noise levels can cause permanent, disabling, hearing loss and other problems such as tinnitus (ringing, buzzing, whistling or humming in the ears);
- Risk assessment of these hazards and implementation of appropriate controls of is essential.
- Appropriate controls to reduce the risk may include actions such as damping materials to prevent work pieces from 'ringing'
- Use hearing protection as instructed by your employer or as required by occupational health and safety regulations;
- Operate and maintain the power tool as recommended in these instructions, to prevent an unnecessary increase in noise levels;
- Select, maintain and replace the consumable/inserted tool as recommended in these instructions, to prevent an unnecessary increase in noise.



## 7.2.2.12 VIBRATION HAZARDS

- Exposure to vibration can cause disabling damage to the nerves and blood supply of the hands and arms;
- Wear warm clothing when working in cold conditions and keep your hands warm and dry;
- If you experience numbness, tingling, pain or whitening of the skin in your fingers or hands, stop using the power tool, and tell your employer. You should also seek medical advice from a qualified occupational health professional.
- Operate and maintain the power tool as recommended in these instructions, to prevent an unnecessary increase in vibration;
- Select, maintain and replace the consumable/inserted tool as recommended in these instructions, to prevent an unnecessary increase in vibration levels;
- Support the weight of the tool in a stand, tensioner or balancer, because the operator can then use a lighter grip to support the tool.
- Hold the tool with a light but safe grip taking account of the required hand reaction forces, because the risk from vibration is generally greater when the grip force is higher.

## 7.2.3 ADDITIONAL SAFETY INSTRUCTIONS FOR PNEUMATIC POWER TOOLS - AIR SUPPLY & CONNECTION HAZARDS

- Air under pressure can cause severe injury.
- Always shut off air supply, drain hose of air pressure and disconnect tool from air supply when not in use, before changing accessories or when making repairs.
- Never direct air at yourself or anyone else.
- Whipping hoses can cause severe injury. Always check for damaged or loose hoses and fittings.
- Whenever universal twist couplings (claw couplings) are used, lock pins must be installed.
- Do not exceed the maximum air pressure stated on the tool.
- Use whip check safety cables to safeguard against possible hose to tool and hose to hose connection failure.
- Never carry an air tool by the hose.

## Safety Information (continued)

### AIR COMPRESSOR AND AIR TOOL SAFETY

1. Risk of Bursting. Do not adjust the regulator to result in output pressure greater than the marked maximum pressure of this air tool.
2. Ensure the hose is free of obstructions or snags. Entangled or snarled hoses can cause loss of balance or footing and may become damaged.
3. Never leave a tool unattended with the air hose attached.
4. Do not operate this tool if it does not contain a legible warning label.
5. Do not continue to use a tool or hose that leaks air or does not function properly.
6. Never direct a jet of compressed air toward people or animals.
7. Protect your lungs. Wear a face or dust mask if the operation is dusty.

**WARNING:** Some dust created by power sanding, sawing, grinding, drilling and other construction activities contains chemicals known to cause cancer, birth defects or other reproductive harm. Some examples of these chemicals are:

Lead from lead based paint, crystalline silica from bricks and cement and other masonry products, arsenic and chromium from chemically-treated lumber.



Your risk from those exposures varies, depending on how often you do this type of work. To reduce your exposure to these chemicals: work in a well-ventilated area, and work with approved safety equipment, such as dust masks that are specifically designed to filter out microscopic particles.

## Important Warnings - Impacts



1. Eye protection and hearing protection and safety gloves must always be worn when operating an impact wrench or impact driver.
2. When using heavy impact sockets or sockets on impact wrenches with 3/4" drive anvils or larger, a socket retaining ring and pin should be used to prevent the socket falling off and causing injury.
3. Use only impact sockets and accessories. Only use sockets designated "FOR USE WITH IMPACT WRENCHES", hand tool sockets can break, creating a hazard from flying pieces. Always check sockets, retainers and drives regularly for wear or damage and replace when necessary.

#### Accessory Hazards

4. Disconnect the assembly power tool for threaded fasteners from the energy supply before changing the inserted tool or accessory.
5. Do not touch sockets or accessories during impacting as this increases the risk of cuts, burns or vibration injuries.
6. Use only sizes and types of accessories and consumables that are recommended by the assembly power tool for threaded fasteners manufacturer; do not use other types or sizes of accessories and consumables.

## Specifications



Vibration Level (m/sec<sup>2</sup>): 7.22



Noise Level (dBA): 90.39

Description	Model No.	Free Speed RPM	Bolt Capacity (in.)	Square Drive (in.)	Reverse Torque	Weight (lbs.)	Length (in.)	Air Inlet (NPT)	Rec. Hose Size (in.)	Rec. Air Pres.	Air Cons. (cfm)
Torque Controlled 1/2" Pistol Impact Wrench	FP-745TCI	8,500	3/4	1/2	800	5.9	9.8	1/4	3/8 I.D.	90 psi	4.6

#### Torque controlled settings ft-lb (Nm)

- |                       |                       |
|-----------------------|-----------------------|
| 1) 65 ft-lb (90 Nm)   | 2) 80 ft-lb (110 Nm)  |
| 3) 100 ft-lb (135 Nm) | 4) 118 ft-lb (160 Nm) |

# Installation

## 1 Cleaning the air hose

- A 3/8" air hose is required, with a maximum length of 25 ft.
- Clean the air hose of accumulated dust and moisture before connecting it to the air supply.



**NOTE:** If a longer air hose is required, connect a 1/2" air hose to the 3/8" air hose to ensure the impact wrench has the necessary air supply.

### Recommended Air Line Set-Up

Part	Description
A	Air Tool
B	Quick Plug
C	Quick Coupler
D	Air Hose
E	In-line Regulator
F	In-line Lubricator
G	In-line Filter
H	Air Compressor

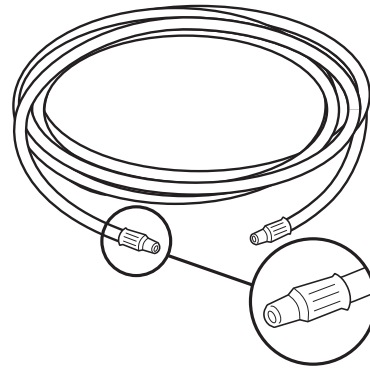

\* Remove the batteries during a long lay-up period.

Battery : AAA 1.5V x 3 pcs  
(Alkaline Batteries are recommended.)

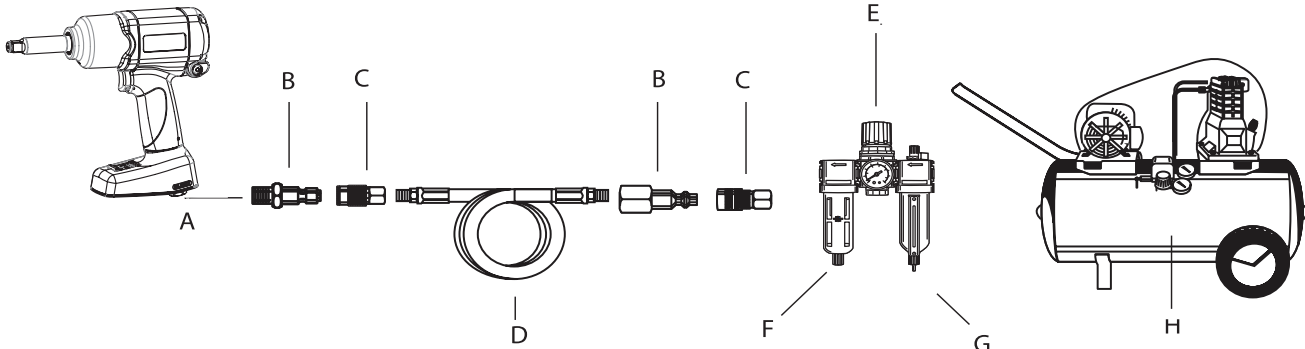
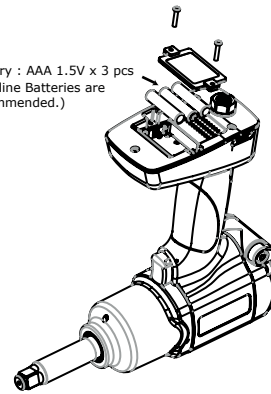

## Maintenance

Ensure the air line is shut-off and drained of air before removing this tool for service or changing sockets. This will prevent the tool from operating if the throttle is accidentally engaged.

### LUBRICATION

- An in-line filter-regulator-lubricator is recommended as it increases tool life and keeps the tool in sustained operation.
- Regularly check and fill the in-line lubricator with air tool oil. Avoid using excessive amounts of oil.
- Adjust the in-line lubricator by placing a sheet of paper next to the tool's exhaust ports and holding the throttle open approximately 30 seconds. The lubricator is properly set when a light stain of oil collects on the paper.
- If it is necessary to store the tool for an extended period of time (overnight, weekend, etc.), generously lubricate the tool through the air inlet. Run the tool for approximately 30 seconds to ensure the oil is evenly distributed throughout the tool. Store the tool in a clean and dry environment.
- Recommended lubricants: Air tool oil or any other high grade turbine oil containing moisture absorbent, rust inhibitors, metal wetting agents, and an EP (extreme pressure) additive.

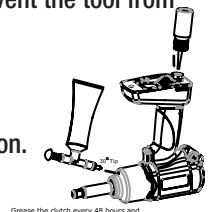

Grease the clutch every 48 hours and  
RP#2 Grease is recommended.

# Operation

## 1 Operating the impact wrench

- This Impact Wrench is designed to operate on 90 PSIG. Lower pressure (below 90 PSIG) will reduce performance of the tool. Higher air pressure (over 90 PSIG) raises the performance of the tool beyond its rated capacity and could cause serious damage to the tool and the user.

### Starting & setting digital display

- Press button once to start
- Press button a second time and hold down to select torque reading in either ft-lb or N-m. **Once the above processes are completed they do not have to be repeated when using the tool.**



## 2 Changing the output torque direction

- This tool features a reverse switch to change the output torque direction to tighten (assemble) or loosen (disassemble) the bolt or fastener.
- Control the output torque direction by pushing the ECD bar in the F (Forward) or R (Reverse) position to change the direction.

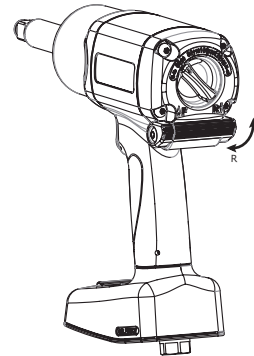

## 3 Changing the output torque level

- The tool always has maximum torque in reverse
- For torque setting in the forward direction, turn the control switch at the rear of the tool to the required torque setting shown on the graduated scale; there are four settings available shown in both ft-lb and Nm

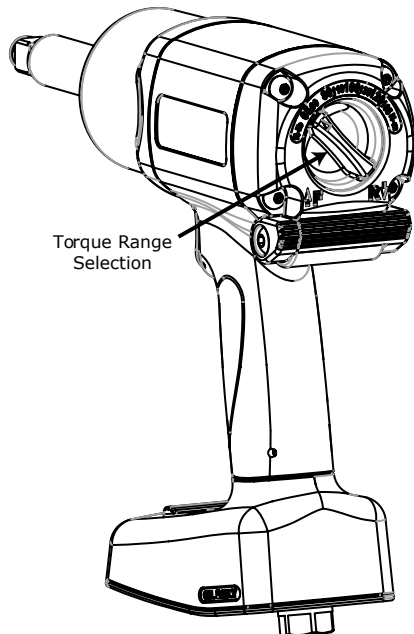

## 4 Tightening/loosening the bolts or fasteners

- Fit the correct size socket to the anvil of the impact wrench.
- For tightening the lug nut set the impact wrench at the required torque setting in forward direction. Do not run the tool prior to placing the socket on the lug nut. Hold the impact wrench with one hand and place the socket onto the lug nut to be tightened. Press the trigger fully and hold down without “feathering” or “interrupting”. Stop the operation as soon as the green indicator light illuminates. Should the red indicator light illuminate check the lug nut with a calibrated torque wrench.
- For loosening the lug nut hold the impact wrench with one hand and set the tool in the reverse direction. Press the trigger until the lug nut is removed.

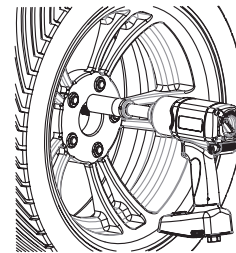

**WARNING:** Once the green indicator light illuminates, stop tightening the lug nut immediately. Continuing to tighten the lug nut after the green light illuminates will stretch or fracture the wheel stud or damage brake components. Always final check lug nut torque with a calibrated torque wrench.

## Troubleshooting

Problem	Possible Cause	Solution
The tool runs slowly or will not operate.	There is grit or gum in the tool.	Flush the tool with air tool oil or gum solvent.
	The tool is out of oil.	Lubricate the tool according to the lubrication instructions in this manual.
	The air pressure is low.	<ul style="list-style-type: none"> <li><input type="checkbox"/> Adjust the regulator on the tool to the maximum setting.</li> <li><input type="checkbox"/> Adjust the compressor regulator to the tool's maximum setting of 90 psi.</li> </ul>
	The air hose leaks.	Tighten and seal the hose fittings with pipe thread tape if leaks are found.
	The air pressure drops.	<ul style="list-style-type: none"> <li><input type="checkbox"/> Ensure the hose is the proper size. Long hoses or tools using large volumes of air may require a hose with an I.D. of ½" or larger depending on the total length of the hose.</li> <li><input type="checkbox"/> Do not use a multiple number of hoses connected together with a quick connect fitting. This causes additional pressure drops and reduces the tool power. Directly connect the hoses together.</li> </ul>
	There is a worn rotor blade in the motor.	Replace the rotor blade.
	There is a worn ball bearing in the motor.	Remove and inspect the bearing for rust, dirt, and grit. Replace or clean and grease the bearing with bearing grease.
There is moisture blowing out of the tool's exhaust.	There is water in the tank.	Drain the tank. (See the air compressor manual for instructions.) Lubricate the tool and run it until water is not evident. Lubricate the tool again and run for 1-2 seconds.
The tool impacts slowly or not at all.	The tool needs lubricating.	Lubricate the air motor and the impact mechanism according to the lubrication instructions in this manual.
	The tool regulator setting is in the wrong position.	Adjust the regulator on the tool to the maximum setting.
The tool impacts rapidly, but will not remove bolts.	The tool has a worn impact mechanism.	Replace the worn impact mechanism components.
The tool does not impact.	The impact mechanism is broken.	Replace the broken impact mechanism components.

## Warranty

Florida Pneumatic Manufacturing Corporation warrants its tools to be free from defects in materials and workmanship. Tools thought to be defective should be returned to the factory, or an authorized service center, transportation charges prepaid, for examination and consequent repair or replacement. This warranty does not cover damage to tools arising from alteration, abuse, or use for other than their intended purpose and does not cover any repairs or replacement made by anyone other than Florida Pneumatic Manufacturing Corporation or its authorized repair stations.

The duration of the Warranty and any other Warranty including, but not limited to, any implied Warranty of merchantability is expressly limited to two years, beginning from the date of the delivery to the original user. The obligation of Florida Pneumatic Manufacturing Corporation under any Warranty, express or implied, is limited solely to the repair or replacement at its factory or authorized repair station of any part which shall prove defective.

# Service Parts / Exploded View Drawing

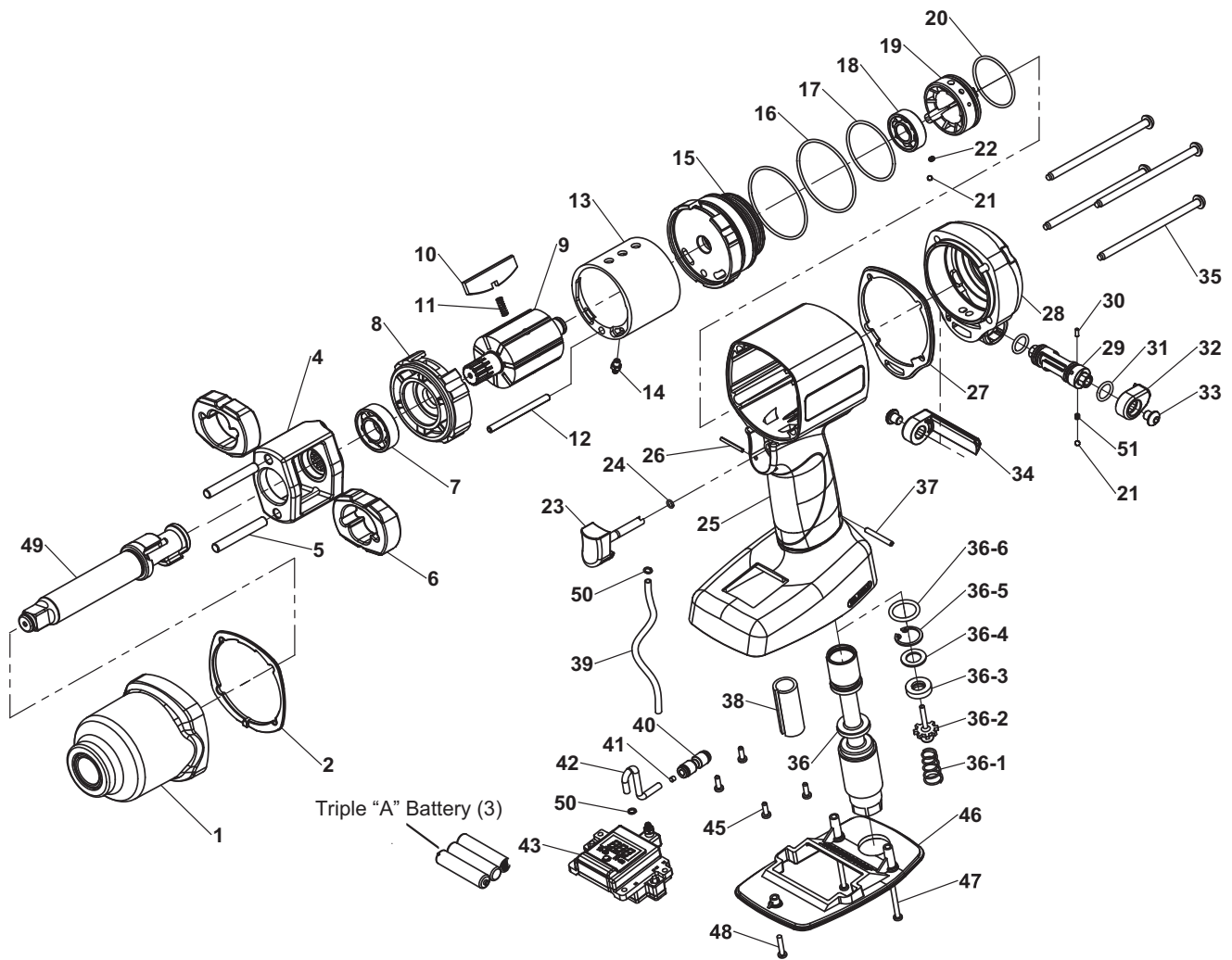

Index No.	Parts No.	Description	Quantity	Index No.	Parts No.	Description	Quantity	Index No.	Parts No.	Description	Quantity
01	924204-B0201	Front Casing Set	1	20	9XOR-AS028	O-Ring	1	36-2	924204-A0102	Pin Valve Rod	1
02	924280-B0106	Packing	1	21	9XBALL-SI18	Steel Ball	2	36-3	924204-A0103	Seal	1
04	924204-A0301	Hammer Cage	1	22	924204-B0310	Spring	1	36-4	924204-A0104	Washer	1
05	924204-A0302	Hammer Pin	2	23	924204-A0400	Trigger	1	36-5	9XCRI-017	Retaining Ring	1
06	924204-A0303	Hammer	2	24	9XOR-0104	O-Ring	1	36-6	9XOR-AS114	O-Ring	1
07	9XBEAR-6002ZZ	Ball Bearing	1	25	924290-B0101	Housing	1	37	9XPIN03-0324	Spring Pin	1
08	924280-A0501	Front Plate	1	26	9XPIN03-002020	Spring Pin	1	38	924204-B0108	Muffler	1
09	924204-A0505	Rotor	1	27	924280-B0105	Packing	1	39	9XPIPE-P004200	Tube	1
10	924204-A0506	Rotor Blade	7	28	924280-B0301	Cover	1	40	9XCONE1-M04	Quick Joint	1
11	924204-A0507	Spring	7	29	924280-B0306	For. / Rev. Director	1	41	9XFILT-PM0303	Filter	1
12	9XPIN03-004055	Spring pin	1	30	9XPIN01-002006	Pin	1	42	9XPIPE-P004050	Tube	1
13	924290-A0502	Cylinder	1	31	9XOR-AS013	O-Ring	2	43	924290-E0100	Digital Gauge Asses.	1
14	924290-A0201	Adaptor	1	32	924280-B0305	Knob	1	45	9XST06-2M03010	Screw	4
15	924280-A0503	Rear Plate	1	33	9XSC07-M06A06	Screw	2	46	924290-B0102	Cover	1
16	9XOR-AS033	O-Ring	2	34	924280-B0304	Knob	1	47	9XSC06-M03A030	Screw	2
17	9XOR-AS030	O-Ring	1	35	924204-M5092	Screw	4	48	9XSC06-M03A016	Screw	1
18	9XBEAR-6001ZZ	Ball Bearing	1	36	924290-A0100	Air Inlet w/preset	1	49	924204-A0314	2" Anvil Set	1
19	924290-A0504	Regulator Knob	1	36-1	924204-A0105	Spring	1	50	924290-A0510	Clip Ring	2
								51	924204-B0320	Spring	1



# AIR TOOLS

Questions, problems, missing parts?

Call Customer Service  
8 a.m.-5 p.m., EST, Monday-Friday

**1-800-356-3392**

**FLORIDA-PNEUMATIC.COM**

Retain this manual for future use.